

F510

TECO   **Westinghouse**

F510

Fan & Pump AC Drive



1-150 HP (230V) • 1-800 HP (460V)

Control Mode Application & Selection Guide

The F510 Fan and Pump AC Drive is an easily configured and versatile drive product that will control almost any application involving fans, blowers, and centrifugal pumps. It comes standard with a simple-to-select preset application parameter for commonly applied fan and pump applications.

A preset application menu designed to simplify start-up is provided for the following applications:

- Pump
- HVAC
- Exhaust Fan

Typical Application Solutions

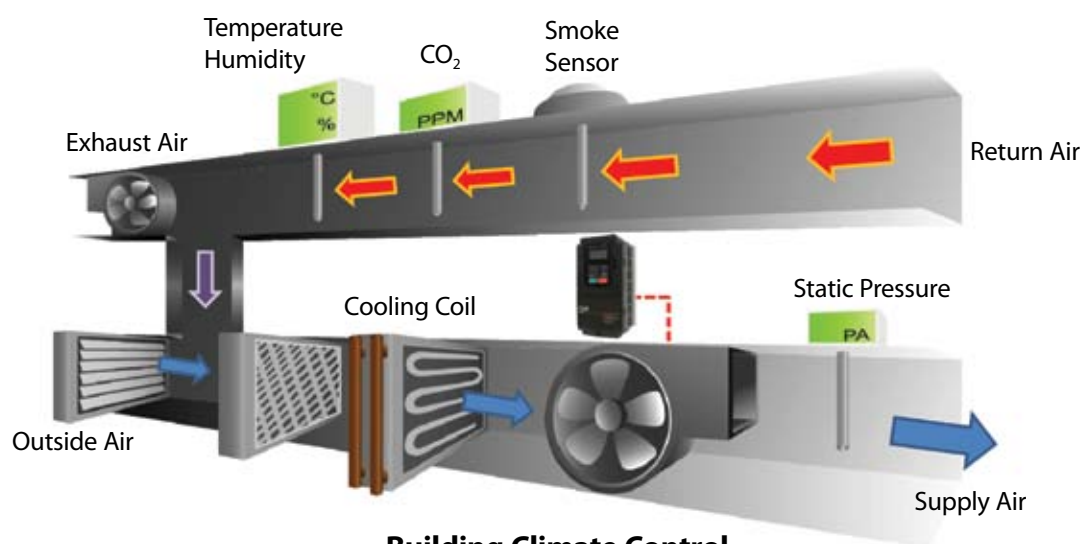

Building Climate Control

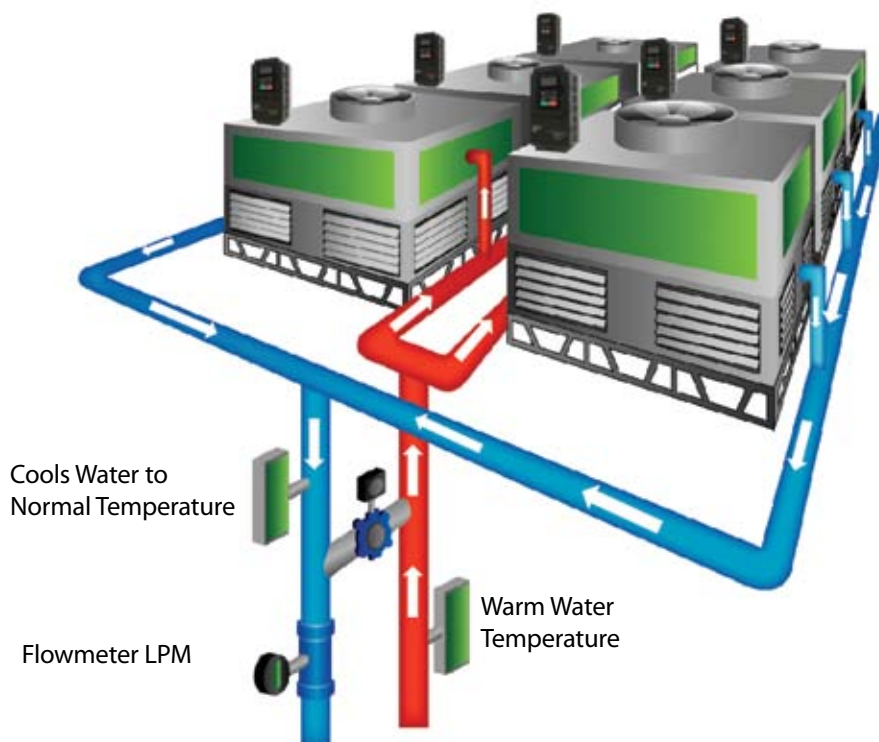

Cooling Tower Water Chiller

Multi-Pump Operation

Regulate up to four pumps to operate at optimum efficiency. A master pump drive operates the flow. If it cannot achieve the desired pressure required for operation, it can activate a second "follower" unit. This process can be repeated using up to 3 "follower" units. As pressure demand decreases, the master unit will selectively deactivate each "follower" unit.

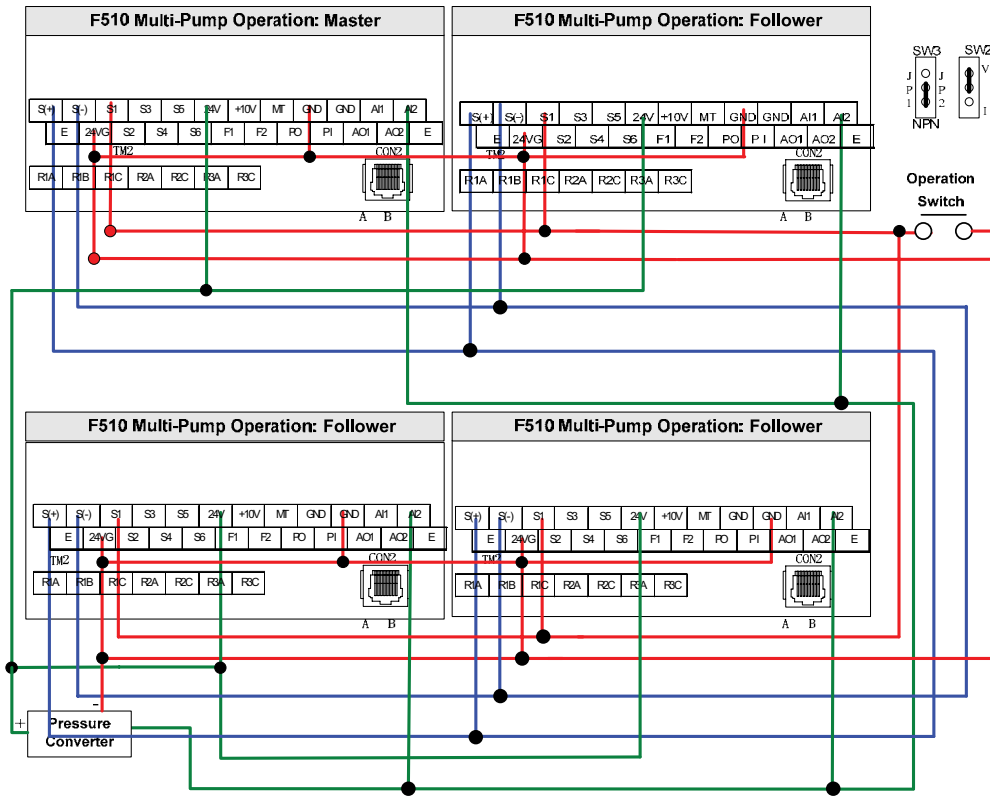

Multi-Pump Wiring Diagram

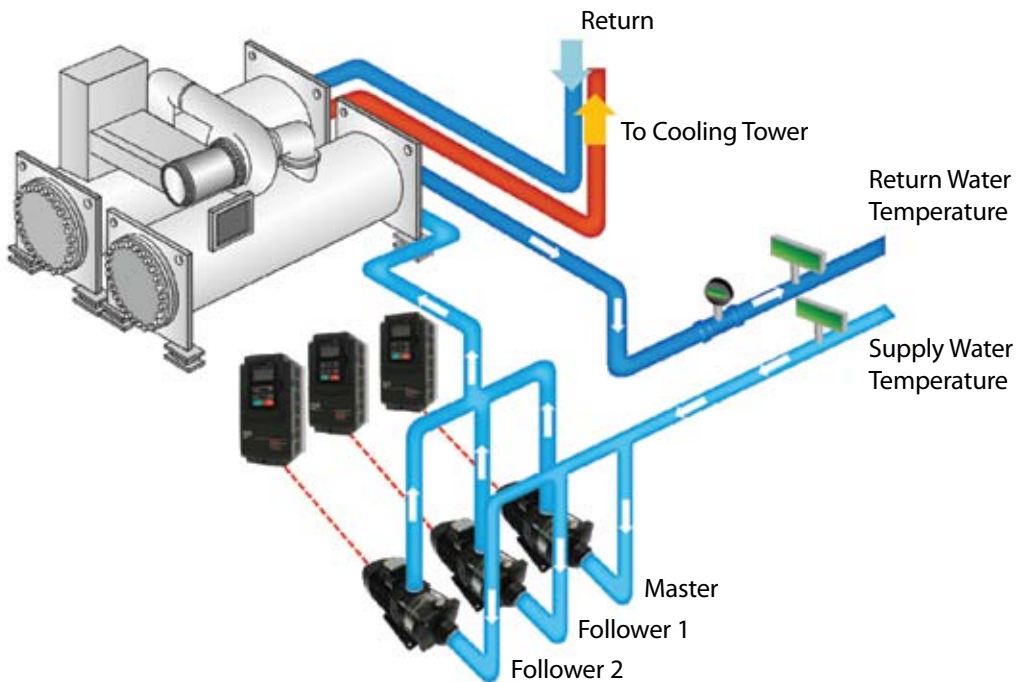

Multi-Stage Pumping Application

Intelligent LCD Keypad with Real-Time Clock

A complete keypad that will control, configure, and closely monitor the F510 unit as it controls operations.

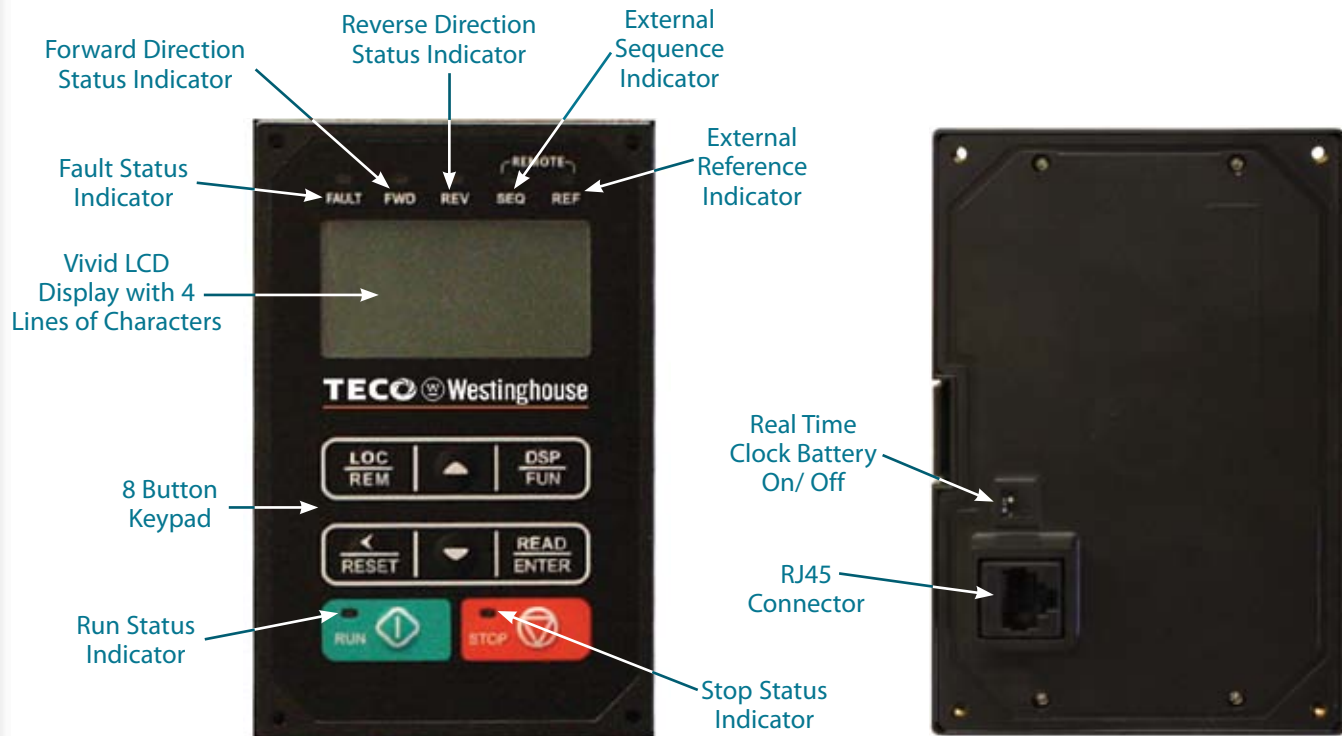

Display	Description
LCD Display	Monitors over 50 inverter signals, view/ edit parameters, fault/ alarm display
LED Indicators	
FAULT	LED ON when a fault or alarm is active
FWD	LED ON when inverter is running in forward direction, flashing when stopping
REV	LED ON when inverter is running in reverse direction, flashing when stopping
SEQ	LED ON when RUN command is from the external control terminals or from serial communication
REF	LED ON when Frequency reference command is from the external control terminals or from serial communication
KEYS (8)	
RUN	RUN inverter in local mode
STOP	STOP inverter
▲	Parameter navigation up, increase parameter or reference value
▼	Parameter navigation down, decrease parameter or reference value
LOC / REM	Used to switch between Local (Keypad) Operation and Remote Operation
DSP / FUN	Used to scroll to next screen Frequency screen → Function selection → Monitor parameter
◀ / RESET	Selects active seven segment digit for editing with the ▲▼ keys Used to reset fault condition
READ / ENTER	Used to read and save the value of the active parameter

Auto-Scroll Keys

Holding the ▲ UP or ▼ DOWN key for a longer period of time will initiate the auto-scroll function resulting in the value of the selected digit to automatically increase or decrease. The LCD keypad can save the configuration file for easy upload/ download.

Features & Highlights

- Ideal product for fan and centrifugal pump applications:
 - HVAC
 - Cooling towers
 - Irrigation
 - Wastewater industries
 - Industrial pumping
- Built-in pump cascade control for up to 4 pumps
 - Option card for control of up to 8 pumps
- Two separate PID loop controls
 - Switch between PID loops based on input signal or real-time clock setting
- Extensive monitoring and display capabilities
- Real time clock built-in (RTC)
- Conformal coating of all printed circuit boards (non-hazardous)
- Plenum Rated
- Built-in Modbus RTU, BACnet MS/TP, or Metasys (N2) communications via on-board RS485 or RJ45 connection
- Built-in PLC functionality
- Scalable process parameters to engineering units
- Digital I/O
 - 6 Configurable digital inputs
 - Over 40 available selections per input
 - Assign inputs as normally open or normally closed
 - 24V power supply on board
 - Extremely fast update time
 - 3 Configurable digital relay outputs
 - Qty (1) form C and (2) form A type relays
 - Over 20 available selections per output
 - Assign outputs as normally open or normally closed
 - Dedicated hardware safety input for user's emergency interface
 - Selectable fast ramp or coast stopping
- Analog I/O
 - 2 Analog inputs
 - One channel assignable as 0-10V or 4-20mA input signal
 - Assignable gain and bias for each channel

Continued on next page >>

Features & Highlights - Continued

- 2 Analog outputs
 - Assignable as 0-10V or 4-20mA signals
 - Over 20 available selections per output
 - Assignable gain and bias for each channel
- PTC input
 - Direct reading of water temperature
- Pulse input and pulse output signals
 - 1 pulse input capable of up to 32 khz
 - 1 pulse output capable of up to 32 khz
- 3 modes of auto tuning to best adapt the F510 with the applied motor
- Controls induction or permanent magnet motors
- 100 Mhz RISC process for ultra-high speed computations and rapid loop-time updates



Models & Ratings

230VAC

Model No.	HP	Amps	Height	Width	Depth	Approx. Weight	Diagram
	Variable Torque	Variable Torque	in/mm	in/mm	in/mm	lbs/kg	
F510-2001-C-U ^(2,4)	1	5.0	9.61/244	5.12/130	5.91/150	5.5/2.5	A
F510-2002-C-U ^(2,4)	2	7.5	9.61/244	5.12/130	5.91/150	5.5/2.5	A
F510-2003-C-U ^(2,4)	3	10.6	9.61/244	5.12/130	5.91/150	5.5/2.5	A
F510-2005-C3-U ⁽²⁾	5	14.5	12.40/315	5.51/140	6.97/177	8.4/3.8	A
F510-2008-C3-U ⁽²⁾	7.5	21	12.40/315	5.51/140	6.97/177	8.4/3.8	A
F510-2010-C3-U ⁽²⁾	10	30	11.81/300	8.27/210	8.46/215	13.6/6.2	B
F510-2015-C3-U ⁽²⁾	15	40	11.81/300	8.27/210	8.46/215	13.6/6.2	B
F510-2020-C3-U ⁽²⁾	20	56	14.17/360	10.43/265	8.86/225	22.0/10	B
F510-2025-C3-U ⁽²⁾	25	69	14.17/360	10.43/265	8.86/225	22.0/10	B
F510-2030-C3-U ⁽²⁾	30	79	14.17/360	10.43/265	8.86/225	22.0/10	B
F510-2040-C3-U	40	110	20.67/525	11.18/284	9.92/252	66.1/30	C
F510-2050-C3-U	50	138	20.67/525	11.18/284	9.92/252	66.1/30	C
F510-2060-C3-U ^(1,3)	60	169	22.83/580	13.54/344	11.81/300	89.3/40.5	D
F510-2075-C3-U ^(1,3)	75	200	22.83/580	13.54/344	11.81/300	89.3/40.5	D
F510-2100-C3-U ^(1,3)	100	250	31.10/790	18.08/459	12.78/324.5	162.8/74	D
F510-2125-C3-U ^(1,3)	125	312	31.10/790	18.08/459	12.78/324.5	162.8/74	D
F510-2150-C3-U ^(1,3)	150	400	39.37/1000	27.16/690	16.14/410	405/184	E

460VAC

Model No.	HP	Amps	Height	Width	Depth	Approx. Weight	Diagram
	Variable Torque	Variable Torque	in/mm	in/mm	in/mm	lbs/kg	
F510-4001-C3-U ⁽²⁾	1	3.4	9.61/244	5.12/130	5.91/150	5.5/2.5	A
F510-4002-C3-U ⁽²⁾	2	4.1	9.61/244	5.12/130	5.91/150	5.5/2.5	A
F510-4003-C3-U ⁽²⁾	3	5.4	9.61/244	5.12/130	5.91/150	5.5/2.5	A
F510-4005-C3-U ⁽²⁾	5	9.2	12.40/315	5.51/140	6.97/177	8.8/3.8	A
F510-4008-C3-U ⁽²⁾	7.5	11.1	12.40/315	5.51/140	6.97/177	8.8/3.8	A
F510-4010-C3-U ⁽²⁾	10	17.5	12.40/315	5.51/140	6.97/177	8.8/3.8	A
F510-4015-C3-U ⁽²⁾	15	23	11.81/300	8.27/210	8.46/215	13.6/6.2	B
F510-4020-C3-U ⁽²⁾	20	31	11.81/300	8.27/210	8.46/215	13.6/6.2	B
F510-4025-C3-U ⁽²⁾	25	38	14.17/360	10.43/265	8.86/225	22.0/10	B
F510-4030-C3-U ⁽²⁾	30	44	14.17/360	10.43/265	8.86/225	22.0/10	B
F510-4040-C3-U ⁽²⁾	40	54	14.17/360	10.43/265	8.86/225	22.0/10	B
F510-4050-C3-U	50	72	20.67/525	11.18/284	9.92/252	66.1/30	C
F510-4060-C3-U	60	88	20.67/525	11.18/284	9.92/252	66.1/30	C
F510-4075-C3-U	75	103	20.67/525	11.18/284	9.92/252	66.1/30	C
F510-4100-C3-U ^(1,3)	100	145	22.83/580	13.7/344	11.81/300	89.3/40.5	D
F510-4125-C3-U ^(1,3)	125	165	22.83/580	13.7/344	11.81/300	89.3/40.5	D
F510-4150-C3-U ^(1,3)	150	208	31.10/790	18.08/459	12.78/324.5	163.1/74	D
F510-4215-C3-U ^(1,3)	200	250	31.10/790	18.08/459	12.78/324.5	163.1/74	D
F510-4250-C3-U ^(1,3)	250	328	31.10/790	18.08/459	12.78/324.5	163.1/74	D
F510-4300-C3-U ^(1,3)	300	435	39.37/1000	27.16/690	16.14/410	405/184	E
F510-4375-C3-U ^(1,3)	350	515	39.37/1000	27.16/690	16.14/410	405/184	E
F510-4425-C3-U ^(1,3)	400	585	39.37/1000	27.16/690	16.14/410	405/184	E
F510-4535-C3-U ^(3,5)	500	690	53.38/1356	37.79/960	19.96/507	640/134	F
F510-4670-C3-U ^(3,5)	600/650	840	53.38/1356	37.79/960	19.96/507	640/134	F
F510-4800-C3-U ^(3,5)	800	960	53.38/1356	37.79/960	19.96/507	640/134	F

- 1) Models include built-in DC Link Reactor.
- 2) Models include built-in Braking Transistor.
- 3) Models are chassis-rated (IP00). NEMA 1 kits are available as options.
- 4) Models accept single or 3-phase 230V input.
Variable Torque: 120% for 1 minute
- 5) Models include External DC reactor

Diagrams referenced are on next page

Dimensional Diagrams

Diagrams refer to the chart on the previous page.

A 1-3 HP, 230V; 1-3 HP, 460V
5-7.5 HP, 230V; 5-10 HP, 460V (IP20; NEMA 1)

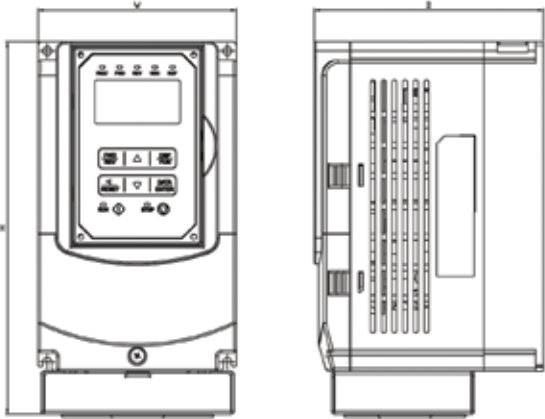

B 10-30 HP, 230V; 15-40 HP, 460V (IP20; NEMA 1)

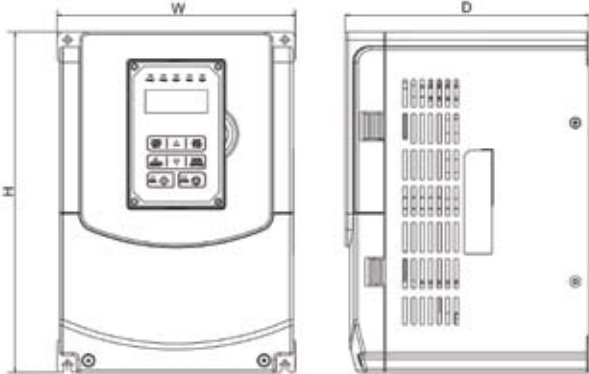

C 40-50 HP, 230V; 50-75 HP, 460V (IP20; NEMA 1)

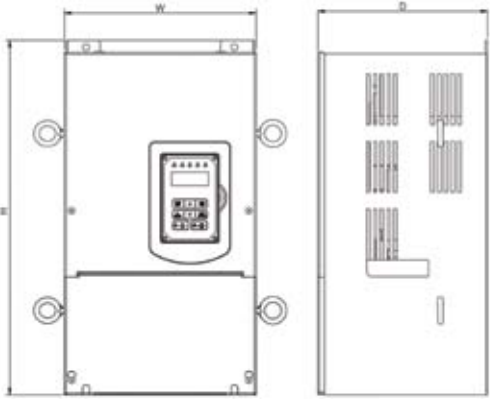

D 60-125 HP, 230V; 100-250 HP, 460V (IP00)

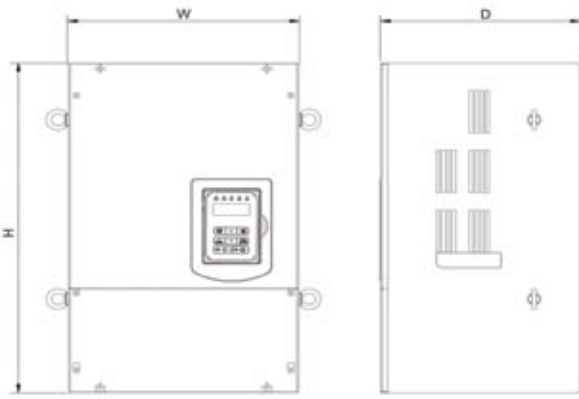

E 150 HP, 230V; 300-400 HP, 460V (IP00)

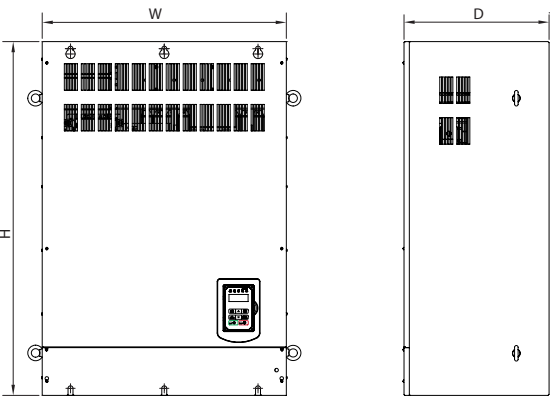

F 500 HP, 600/650 HP, 800 HP (460V)

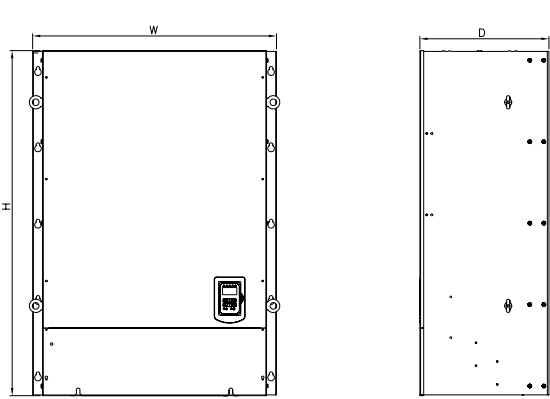

Connection Diagram

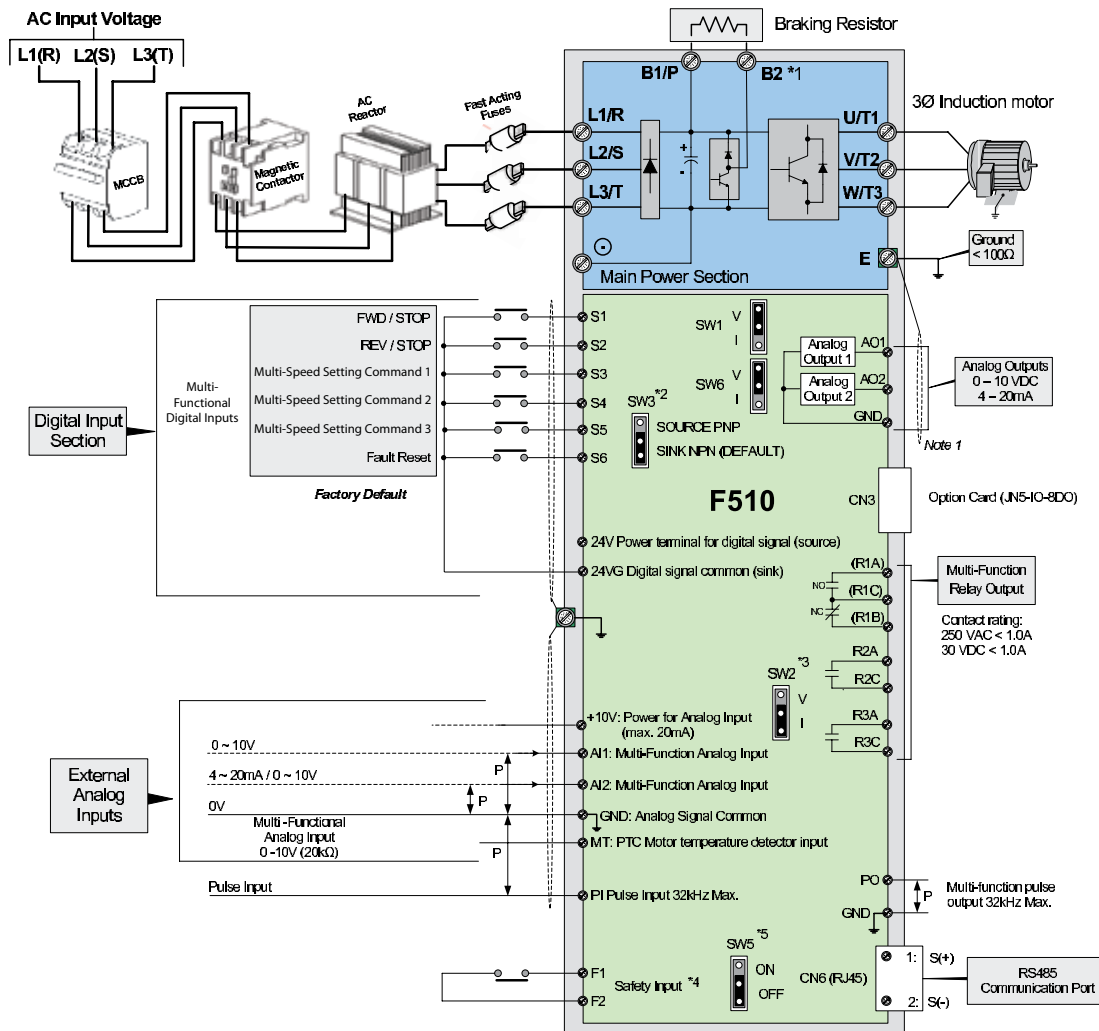

*1 - Models that are IP20, 1-30 HP (230V) and 1-40 HP (460V), have a built-in braking transistor. To use this braking transistor, the braking resistor can be connected between terminal B1 and B2.

*2 - Use SW3 to select between Sink (NPN, with 24VG common-default) or Source (PNP, with +24V common) for multi-function digital input terminals S1-S6.

*3 - Use SW2 to switch between voltage and current input for multi-function analog input 2 (AI2).

*4 - Safety input F1 and F2 is a normally closed input. This input should be closed to enable the inverter output. To activate this input, remove the jumper wire between F1 and F2.

*5 - Terminating resistor can be set on or bypassed (off). This is used when connecting multiple drives in an RS485 network.

Operating Features & Characteristics

Operation Mode	LCD Keypad with Parameter Copy Function
Control modes	Volts/Hz (V/F), Sensorless Vector (SLV), Sensorless Vector with Permanent Magnet Motor (PMSLV)
Frequency control range	0.1Hz ~ 400.0Hz
Frequency accuracy (Temperature change)	Digital references: $\pm 0.01\%$ (-10~+40°C), Analog references: $\pm 0.10\%$ (25°C $\pm 10^\circ\text{C}$)
Speed control accuracy	$\pm 0.5\%$ (sensorless vector mode)
Frequency setting resolution	Digital references: 0.01Hz, Analog references: 0.06Hz/60Hz
Output frequency resolution	0.01Hz
Overload tolerance rated output current	120%/1 min
Frequency setting signal	0 ~ +10VDC/ -10VDC ~+10VDC or 4~20mA, digital presets, RS485 communications and pulse-type frequency command
Acceleration/ deceleration time	0.0~6000.0 sec (separately set acceleration and deceleration times)
Voltage, frequency characteristics	Preset V/F menu can set custom V/F-curve based on parameters
Braking torque	Approximately 20%
Main control functions	Auto tuning, droop control, soft-switching in PWM, over voltage protection, dynamic braking, speed search, instantaneous power fault restart, two sets of PID control, slip compensation, RS485 communication Modbus RTU, METASYS (N2), or BACnet MS/TP standard, speed feedback control, simple PLC functionality, two sets of analog output, safety switch interlock
Additional control functions	Record of elapsed power-up and operation times, 4 most recent occurrences of faults and the most recent fault record status, energy-saving function setting, phase loss protection, smart braking, DC braking, dwell, S-curve acceleration and deceleration, Up/ Down operation, energy meter, pulse output, engineering unit display, Local/ Remote switching key, SINK/ SOURCE input interface options

Operations Features & Characteristics - Continued

Operation Mode		LCD Keypad with Parameter Copy Function
Protection Features	Stall protection	Threshold current can be set. (In acceleration or constant speed, it can be set separately. In deceleration it can be set on or off)
	Instantaneous Over Current (OC) and output Short Circuit (SC) protection	Inverter shuts off when the current exceeds 160% of the inverter rated current.
	Inverter Overload protection (OL2)	Inverter rated current is 120%/1 min. Inverter shuts off when the current is higher than 120% of the rated current for 1 min. Default carrier frequency factory setting is 2-4 kHz.
	Motor Overload (OL1) protection	Electrical overload protection curve
	Over Voltage (OV) protection	When the main circuit DC voltage exceeds 410V (230V units)/ 820V (460V units), the drive faults out regardless of whether it is in run mode or stopped.
	Under Voltage (UV)	When the main circuit DC voltage is under 190V (230V units)/ 380V (460V units), the drive faults out regardless of whether it is in run mode or stopped. The DC voltage trigger level can be adjusted.
	Automatic restart after instantaneous power fault	Power fault exceeds 15 ms. This is programmable to 2 seconds.
	Overheat protection (OH)	By direct temperature detection in the unit
	Ground Fault protection (GF)	Uses current feedback for protection
	Protection in charge state	When main circuit DC voltage exceeds 50V, the "CHARGE" LED is on.
	Output Phase Loss protection (OPL)	Automatically stops motor rotation and faults
Environmental Specifications	Location	Indoor (protected from corrosive gases and dust) Plenum Rated
	Ambient temperature	-10~+40°C without derating (IP20/NEMA1), -10~+50°C (IP00), with derating, its maximum operation temperature is 60°C
	Storage temperature	-20~+70°C
	Humidity	95%RH or less (no condensation)
	Altitude and vibration	Altitude of 1,000 m (3,300 ft) or lower, vibration below 5.9 m/s ² (0.6G)
Communication function	RS485 standard with built-in (MODBUS/ BACNet/ Metasys N2) (RJ45)	
PLC function	Built-in	
EMI protection	The added noise filter complies with EN61800-3; 460V, 75 HP or below can be built-in.	
EMS protection	Follows EN61800-3	
Options	1 to 8 Pump card, HOA LCD Keypad, Profibus Card	

Protection Features

- ASIC designed to protect transistor modules from impact of sudden or rapidly changing current
- EMC filters are available on all 460VAC rated models. Please consult factory.
- Regenerative energy control and over voltage prevention

32 Bit MCU

Provides high speed current vector computing. Reduces internal loop time for higher response.

ASIC – Avoid inrush current damage on IGBTs. Enhances the reliability and lifespan.

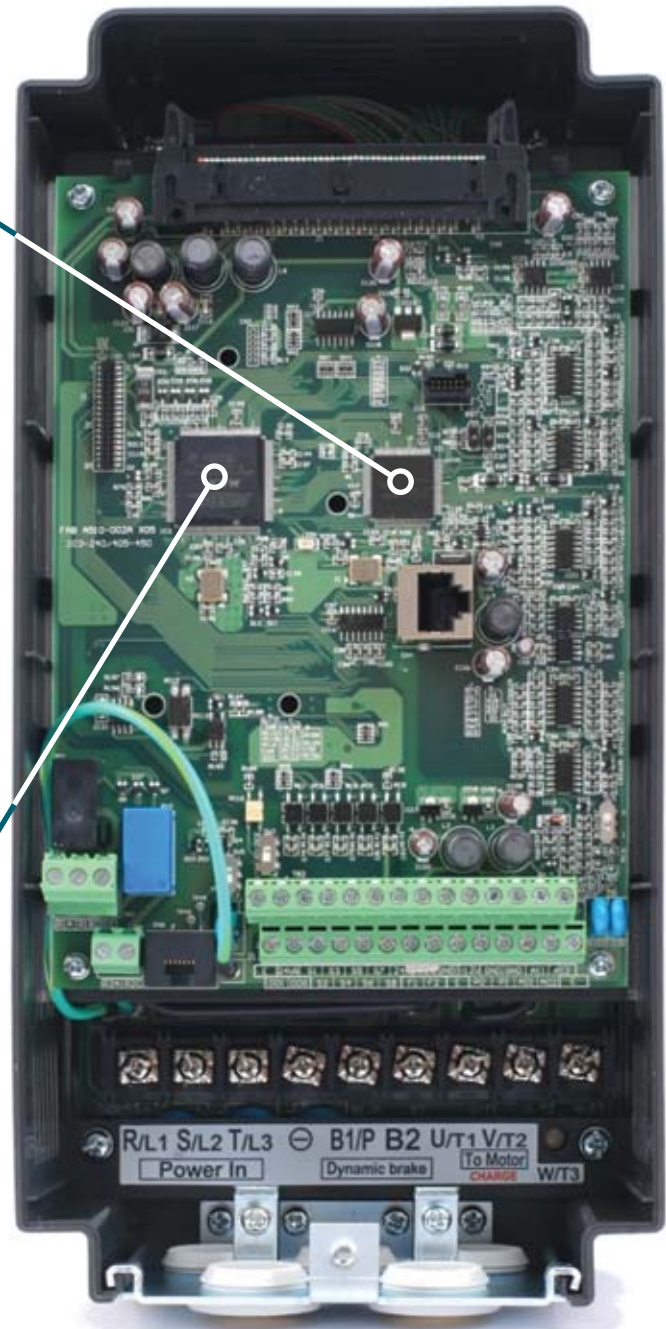

Programmable Logic Control (PLC) Capabilities

Applications with more demanding or complex requirements or restrictions on operation can be met with simple PLC functions used directly in the drive unit. For example, the application may be triggered by special operation sequencing or multiple independent events. Another possibility for the PLC functions is a system with permissives that cannot be adequately incorporated through the I/O alone.

The PLC function features different types of instruction blocks that will build a ladder logic program.

■ Software relay functions

- Input contacts
- Output coils
- Internal software coils
- Normally open, normally closed, and edge-triggered contacts

■ Numerical function blocks

- Counters (count up or count down to preset value)
- On-delay, off-delay, and on-off interval timing
- Analog comparator to trigger an event when an analog input or internal numerical value is above, below, or within range of a set value
- Operation control functions to run the driven motor
- Add/ subtract and multiply/ divide blocks for signal scaling and conditioning

Example: Relay and Timer Functions

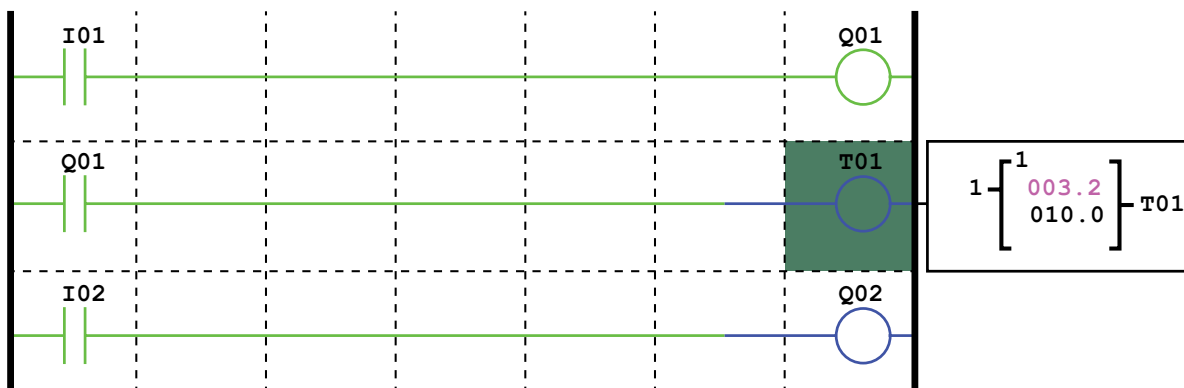

Options & Accessories

The 1 to 8 pump card allows the F510 to control a system where up to 8 pumps operate on a common fluid flow operation. The overall process demand, as a signal to the F510, determines the number of pumps enabled.

JN5-IO-8D0	1 to 8 Pump Card
------------	------------------



1 to 8 Pump Card

The F510 product has a standard RS485 port with RTU Modbus Metasys, and BACNet protocols. An optional card for Profibus Communications is available.

JN5-CM-PDP	Profibus Communications Module
------------	--------------------------------

Extension cables for remote mounting of the operator's keypad. Select cables below according to the desired distance from the drive.

JN5-CB-01M	1 Meter
JN5-CB-02M	2 Meters
JN5-CB-03M	3 Meters
JN5-CB-05M	5 Meters

NEMA 1 adaptor kits are available for the larger size drives that are built as IP00 units.

JN5-NK-A06	Adaptor kit for 230V, 60-75 HP and 460V, 100-125 HP
JN5-NK-A07	Adaptor kit for 230V, 100-125 HP and 460V, 150-250 HP
JN5-NK-A08	Adaptor kit for 230V, 150 HP and 460V, 300-400 HP
JN5-NK-A09	Adaptor kit for 460V, 500-800 HP
E015	Adaptor kit for 460V, 500-800 HP DC Link Reactor

Configured Packages

HVAC Packages

TECO-Westinghouse offers a complete line of packaged drives, including bypass packages for fan and pump applications.

Features

- Packages up to 1000 HP available
- Available in multiple disconnect options
- Two or three contactor and soft start bypass
- Wide range of harmonic filters available to meet IEEE 519-1992
- NEMA 1, NEMA 12, NEMA 3R standard
- NEMA 4 & 4X available (custom order)
- Duplex - multiplex packages available
- Packages designed to customer specifications



Applications

- Fans
- Chillers
- Refrigeration
- Compressors
- Air handlers
- Pumps

Industrial Packages

TECO-Westinghouse additionally offers packaged drives to suit robust industrial applications.

Features

- Packages up to 1000 HP
- Available in multiple disconnect options
- NEMA 1, NEMA 12, NEMA 3R standard
- NEMA 4 & 4X available (custom order)
- Special designs to meet tight spacing requirements

Applications

- Conveyors
- Compressors
- Mixers
- Stamping/ punch press



TECO **Westinghouse**

TECO-Westinghouse Motor Company offers an extensive line of Variable Speed Drives and Soft Starters for your motor control applications.

We also offer a wide variety of motors that are matched with the Drives and Soft Starters including Vertical Hollow Shaft, Rolled Steel, and NEMA Premium Efficient motors.

From “in stock” controls to engineered systems, we can provide you the right control solution including an extensive line of TECO-Westinghouse AC motors.



TECO **Westinghouse**

5100 N. IH-35
Round Rock, Texas 78681
1-800-279-4007

www.tecowestinghouse.com

D-F510 5-18

